

**P44-R-G DESCRIPTION**

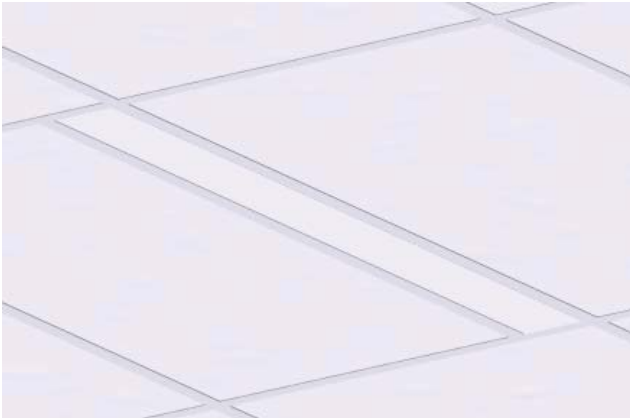

Catalog #	Type
Project	
Comments	
Prepared by	Date

The Prime 44-R-G is designed around energy efficient T5, T5HO and T8 lamps for maximum performance. Prime 44-R-G is the next evolutionary step in classic fixture design. It utilizes the latest technological advances in lamp, ballast and optic improvements. ICON is also breaking new ground by re-engineering mounting and joining detail to help project renovations.

**P44-R-G SPECIFICATIONS**

- CONSTRUCTION** Code gauge cold rolled steel housing. 6063-T5 extruded aluminum ceiling flange with integral trim.
- MOUNT** T-bar mount uni-clip support bracket furnished as standard for simplifying and reducing overall cost of installation.
- OPTICS** High performance white hybrid powder coat applied to an optically optimized reflector system. Semi-specular blades with specular side rails or white parabolic high cut off louver. Continuous matte white lens is standard.
- ELECTRICAL** Pre-wired with factory installed branch circuit wiring and over-molded quick connects. Removable ballast tray. Quick access wire plate. UL listed class "P" thermally protected electronic ballast with less than 10% THD.

- FINISH** Standard housing finished in ICON White powder coat applied over a 5-stage corrosion inhibiting pre-treatment. Transparent color over bonded chrome finish available. Alternate finishes available.
- APPLICATIONS** Retail, Grocery Store, Educational Facility, Library, Open Office, Private Office, Reception Area, Conference Room, Lobby, Corridor, Rest Room, Medical Center, Museum.
- OTHER** Energy saving options available (consult factory)

PRIME PRIME 44 RECESSED GRID

**P44-R-G LAMP CONFIGURATIONS**

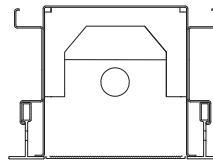
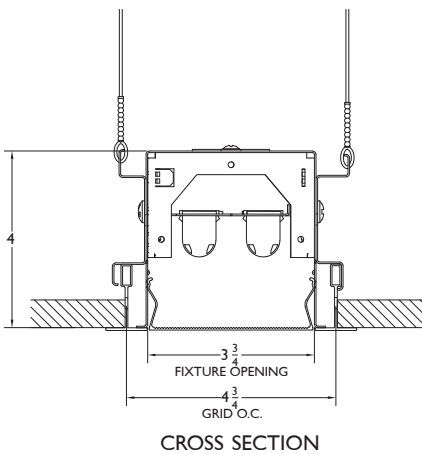

1 T5

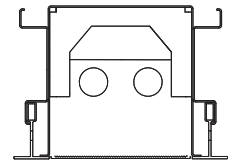

2 T5

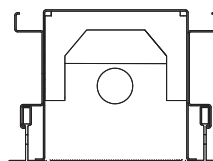

1 T8

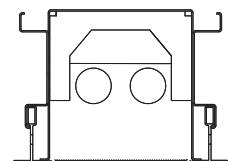

2 T8

**PRIME 44-R-G PHOTO DISTRIBUTION**

Candela Tabulation

Photometry based on standard

Total Luminaire Efficiency: 65.9%:

VERTICAL ANGLE	CANDLEPOWER DISTRIBUTION					
	HORIZONTAL ANGLE 22.5		45		67.5	90
0	1399.5	1399.5	1399.5	1399.5	1399.5	
5	1364.4	1345.8	1332.0	1355.2	1329.5	
10	1329.2	1312.8	1353.9	1334.5	1311.3	
15	1276.1	1303.8	1308.4	1282.0	1275.2	
20	1268.6	1264.7	1253.7	1263.4	1284.6	
25	1203.1	1198.1	1198.2	1210.8	1217.4	
30	1119.5	1126.6	1130.0	1143.8	1130.4	
35	1026.6	1042.0	1042.4	1045.2	1060.0	
40	940.1	953.2	951.6	977.3	975.4	
45	870.3	865.1	873.9	887.0	863.6	
50	781.5	784.3	776.6	772.0	762.2	
55	680.7	678.0	670.0	667.0	659.3	
60	562.1	576.7	589.2	576.1	570.5	
65	452.6	450.1	472.4	470.8	466.0	
70	380.3	379.0	361.1	371.7	366.2	
75	263.4	269.5	274.3	267.5	269.4	
80	130.9	138.4	165.8	194.2	186.7	
85	53.6	51.1	66.6	107.8	109.8	
90	14.1	13.4	24.1	56.9	67.5	

IES SPACING CRITERIA: END = 1.20 DIAGONAL = 1.34 CROSS = 1.22

Zonal Lumens

Zone	Lumens	%Lamp	%Fixt
0-30	1049.36	18.1	27.4
0-40	1703.79	29.4	44.6
0-60	2980.35	51.4	77.9
0-90	3823.79	65.9	100
90-120	0	0	0
90-130	0	0	0
90-150	0	0	0
90-180	0	0	0
0-180	3823.79	65.9	100

Total Luminaire Efficiency = 65.90%

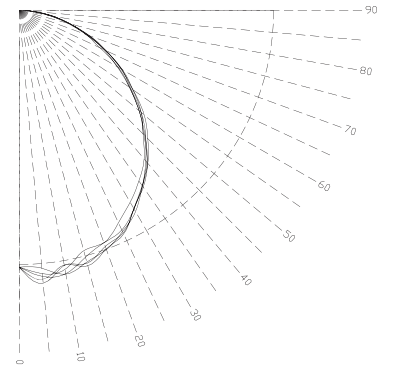

Coefficients of Utilization- Zonal Cavity Method

Effective Floor Cavity Reflectance 0.20

RC	80				70				50				30				10				0		
	RW	70	50	30	10	70	50	30	10	50	30	10	50	30	10	50	30	10	50	30	10	0	
0		78	78	78	78	77	77	77	77	73	73	73	70	70	70	67	67	67	66				66
1		71	68	65	63	70	67	64	62	64	62	60	61	60	58	59	57	56	55				55
2		65	59	55	51	63	58	54	50	56	52	49	54	51	48	52	49	47	45				45
3		59	52	47	42	58	51	46	42	49	45	41	47	44	40	46	42	40	38				38
4		54	46	40	36	53	45	40	36	44	39	35	42	38	35	41	37	34	33				33
5		50	41	35	31	48	40	35	31	39	34	30	38	33	30	37	33	30	28				28
6		46	37	31	27	45	36	31	27	35	30	27	34	30	26	33	29	26	25				25
7		43	34	28	24	41	33	28	24	32	27	23	31	27	23	30	26	23	22				22
8		40	31	25	21	39	30	25	21	29	24	21	29	24	21	28	24	21	19				19
9		37	28	23	19	36	28	23	19	27	22	19	26	22	19	26	22	19	18				18
10		35	26	21	17	34	26	21	17	25	20	17	24	20	17	24	20	17	16				16

**P44-R-G MOUNTING**

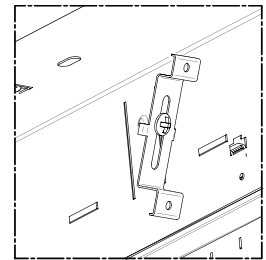
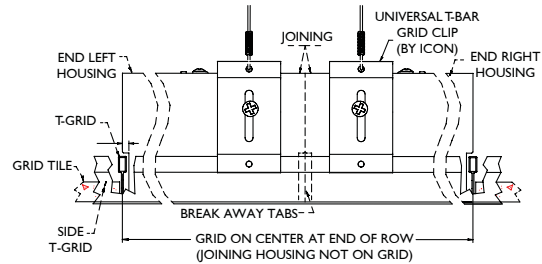
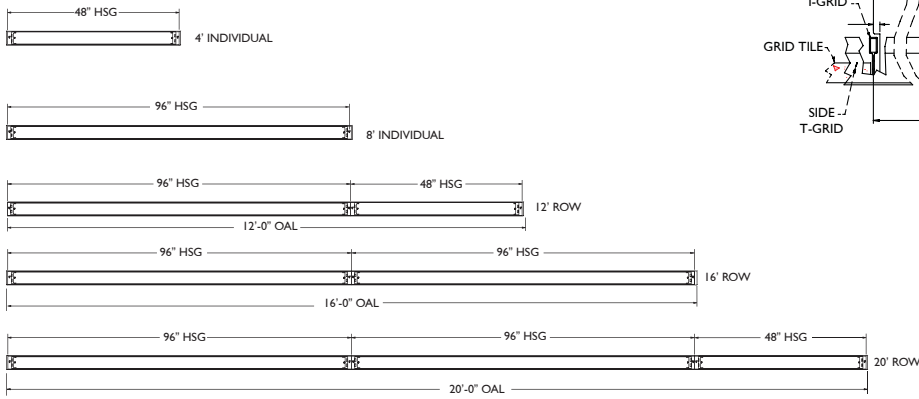

**P44-R-G ORDERING KEY**

EXAMPLE P44-R-G-2-T5-EWL-S-U-EBI0-W-4

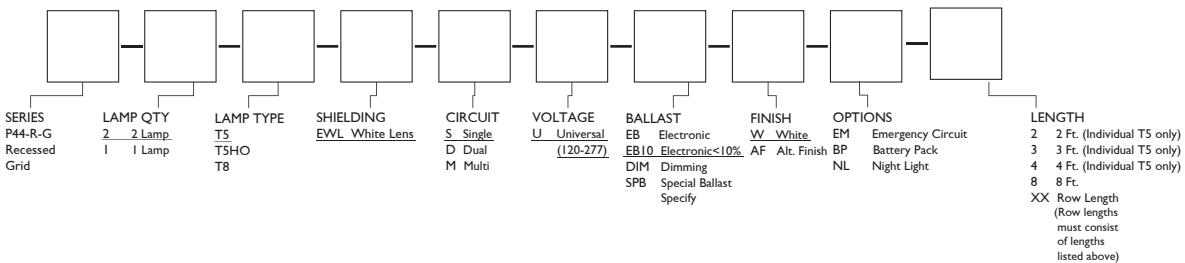

\*Consult Manufacturer

Underline signifies standard configuration

UL listed and IBEW-AFL made (product affixed with UL and IBEW labels)

ICON International reserves the right to change specifications for product improvements without notification

